

Article number: 20194V45V452BL

Description: E+G
T-angel clamps GN194-V45-V45-2-BL

Measures

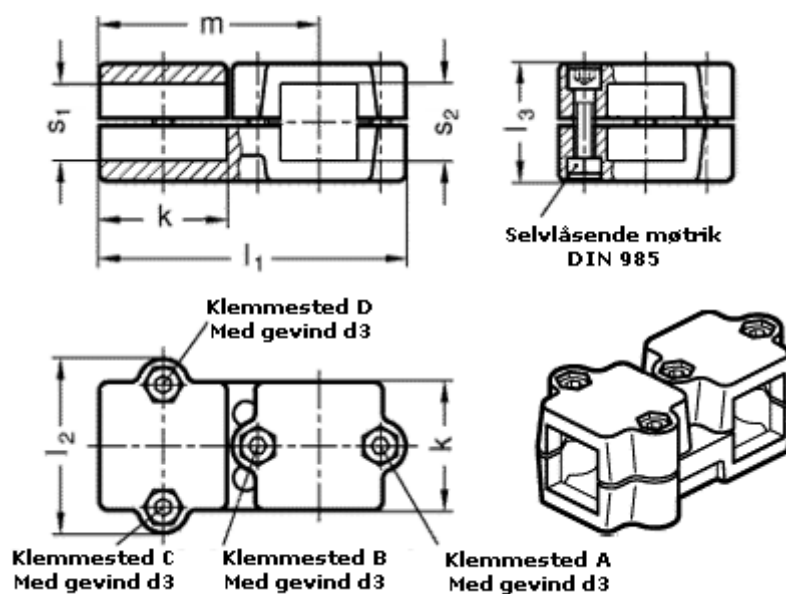

d3 = M10

k = 76

l1 = 176

l2 = 98

l3 = 70

m = 126

s1 = 45

s2 = 45